

SV8150

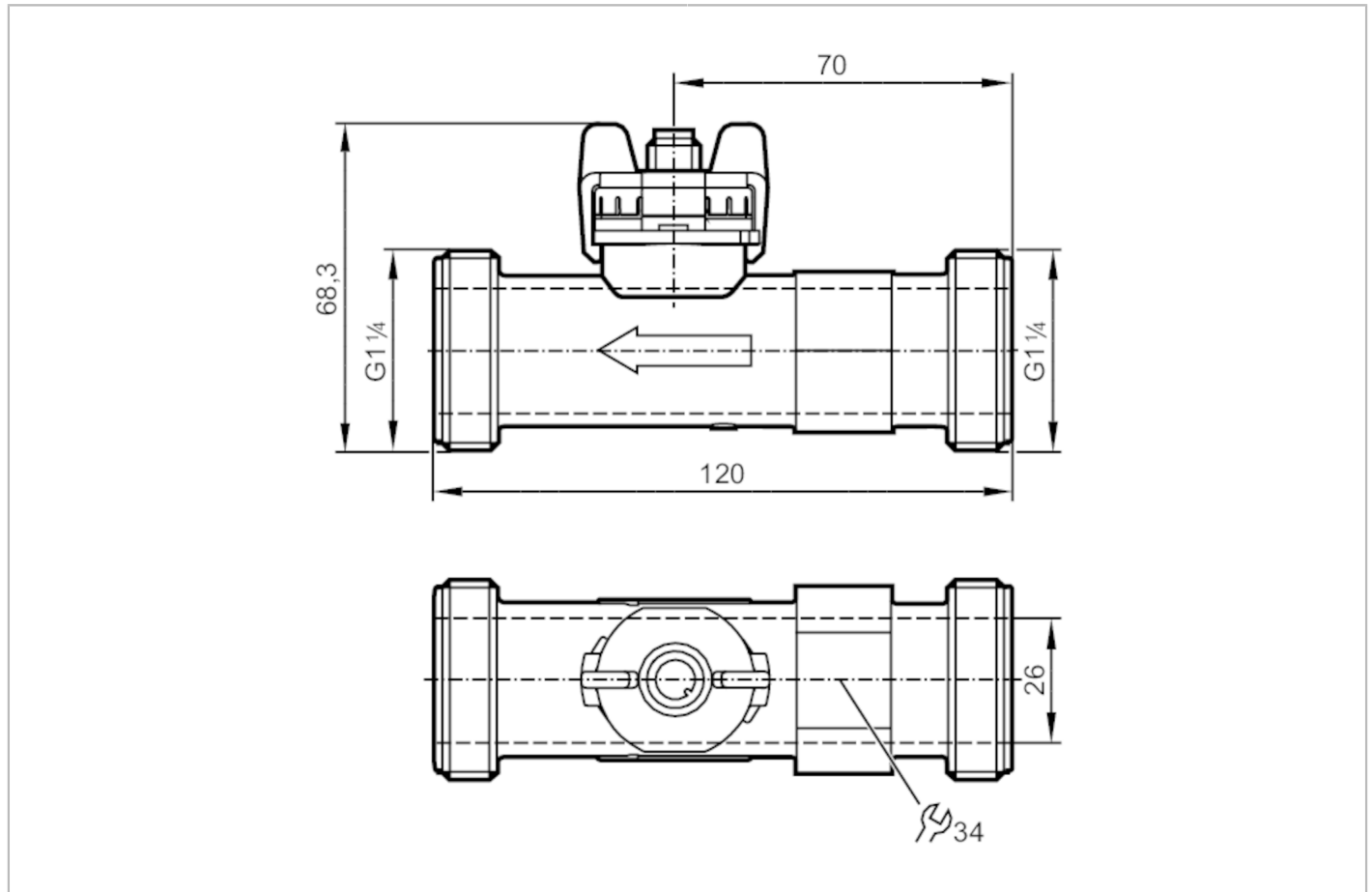

Vortex flow meter

SVM54XXXD0KG/US-100



Product characteristics

Number of inputs and outputs	Number of analogue outputs: 1	
Measuring range	9...150 l/min	0.283...4.709 m/s
Process connection	threaded connection G 1 1/4 external thread DN25	

Application

Special feature	Gold-plated contacts	
Measuring element	1 x Pt 1000; (to DIN EN 60751, class B)	
Application	for industrial applications	
Installation	connection to pipe by means of an adapter	
Media	water; glycol solutions; coolants	
Medium temperature [°C]	-40...100	
Min. bursting pressure [bar]	25	
Min. bursting pressure [MPa]	2.5	
Pressure rating [bar]	12	
Pressure rating [MPa]	1.2	
Note on pressure rating	up to 40 °C	

Electrical data

Operating voltage [V]	8...33 DC	
Min. insulation resistance [MΩ]	100; (500 V DC)	

SV8150



Vortex flow meter

SVM54XXXD0KG/US-100

Protection class	III
Power-on delay time [s]	< 2
Measuring principle	Vortex

Inputs / outputs

Number of inputs and outputs	Number of analogue outputs: 1
------------------------------	-------------------------------

Outputs

Total number of outputs	1
Output signal	analogue signal
Number of analogue outputs	1
Analogue current output [mA]	4...20; (water: $Q [l/min] = 9,375 \times (I - 4 \text{ mA})$; water-glycol: $Q [l/min] = 9,375 \times (I - 4 \text{ mA}) - Q_0$ see Figure 2)
Max. load [Ω]	$< (U_b - 8 \text{ V}) / 20 \text{ mA}$; $U_b = 24 \text{ V}$: 800

Measuring/setting range

Measuring range	9...150 l/min	0.283...4.709 m/s
-----------------	---------------	-------------------

Temperature monitoring

Internal heating temperature probe	1 K/mW
Measuring range [$^{\circ}\text{C}$]	-40...100

Accuracy / deviations

Flow monitoring

Accuracy (in the measuring range)	$Q < 50 \% \text{ MEW}: < 1 \% \text{ MEW} / Q > 50 \% \text{ MEW}: < 2 \% \text{ MW}$; (water)
Repeatability	0,2; (% of the final value)

Temperature monitoring

Accuracy [K]	$\pm 0,3 \pm 0,005 \times T$
--------------	------------------------------

Response times

Flow monitoring

Response time [s]	0.5
-------------------	-----

Operating conditions

Ambient temperature [$^{\circ}\text{C}$]	-15...85
Note on ambient temperature	medium temperature $> 0^{\circ}\text{C}$: -30...85
Storage temperature [$^{\circ}\text{C}$]	-30...85
Protection	IP 65
Cavitation	$P(\text{absolute discharge}) / P(\text{difference}) > 5.5$ to avoid cavitation

Tests / approvals

EMC	EN 61326-2-3	
Shock resistance	DIN EN 60068-2-27	30 g (11 ms)
Vibration resistance	DIN EN 60068-2-6	with water / 10...61 Hz 1 mm with water / 61...2000 Hz 2 g
MTTF [years]		380
Pressure Equipment Directive	Sound engineering practice; can be used for group 2 fluids; group 1 fluids on request	

Mechanical data

Weight [g]	136.2
Housing	rectangular

SV8150



Vortex flow meter

SVM54XXXD0KG/US-100

Dimensions	[mm]	120 x 41.91 x 68.3
Materials		PA 6T
Materials (wetted parts)		ETFE; PA 6T; EPDM
Tightening torque	[Nm]	15
Process connection		threaded connection G 1 1/4 external thread DN25

Displays / operating elements

Display		colour display 1,44", 128 x 128 pixels 2 x LED, yellow
---------	--	---

Remarks

Remarks		MW = measured value MEW = Final value of the measuring range
Pack quantity		1 pcs.

Electrical connection

Connector: 1 x M12; coding: A; Contacts: gold-plated



Connection

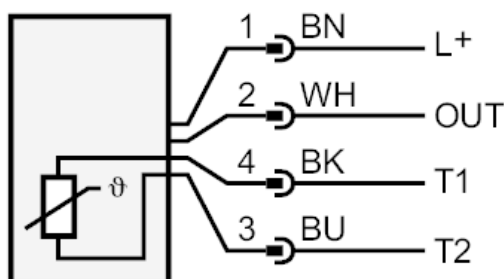

OUT: analogue output
 T1 / T2: Pt1000
 colours to DIN EN 60947-5-2
 Core colours :
 BK = black
 BN = brown
 BU = blue
 WH = white

SV8150

Vortex flow meter

SVM54XXXD0KG/US-100



Diagrams and graphs

Pressure loss

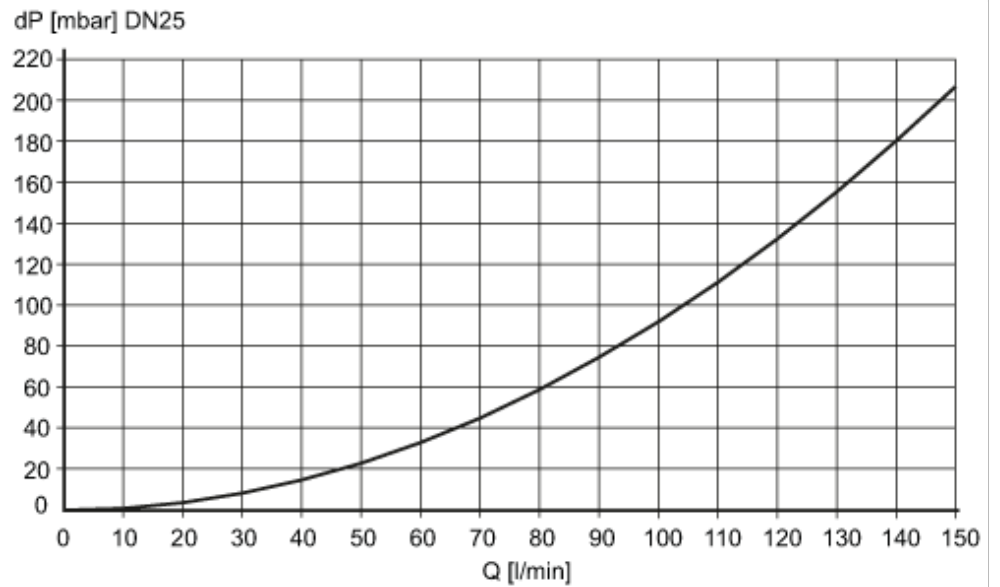

dP Pressure loss

Q volumetric flow quantity

min. life 10 years referred to flow and high medium temperatures

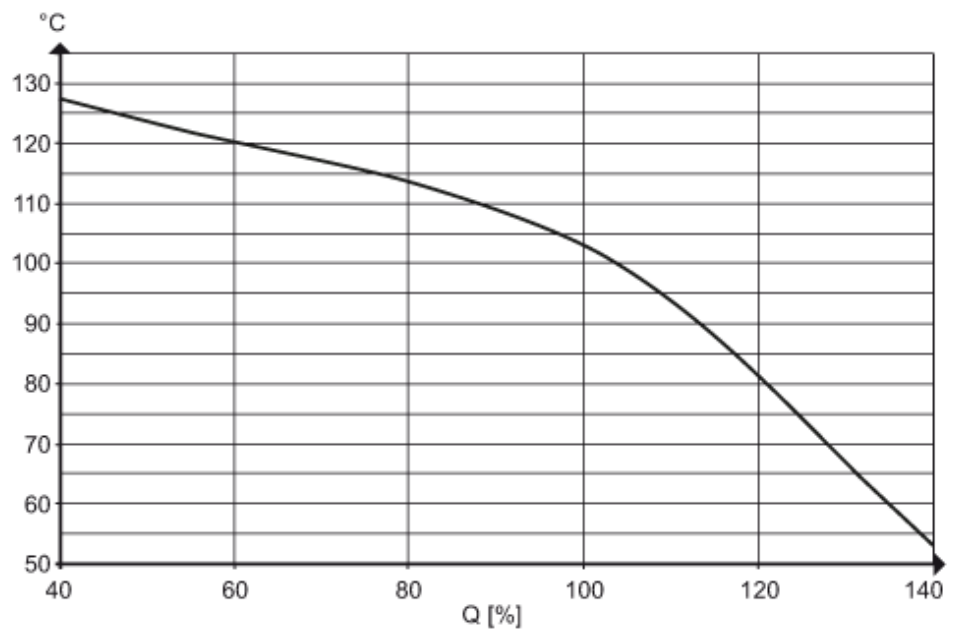

SV8150



Vortex flow meter

SVM54XXXD0KG/US-100

determination of the kinematic viscosity (ν) of glycol-water mixtures depending on the temperature

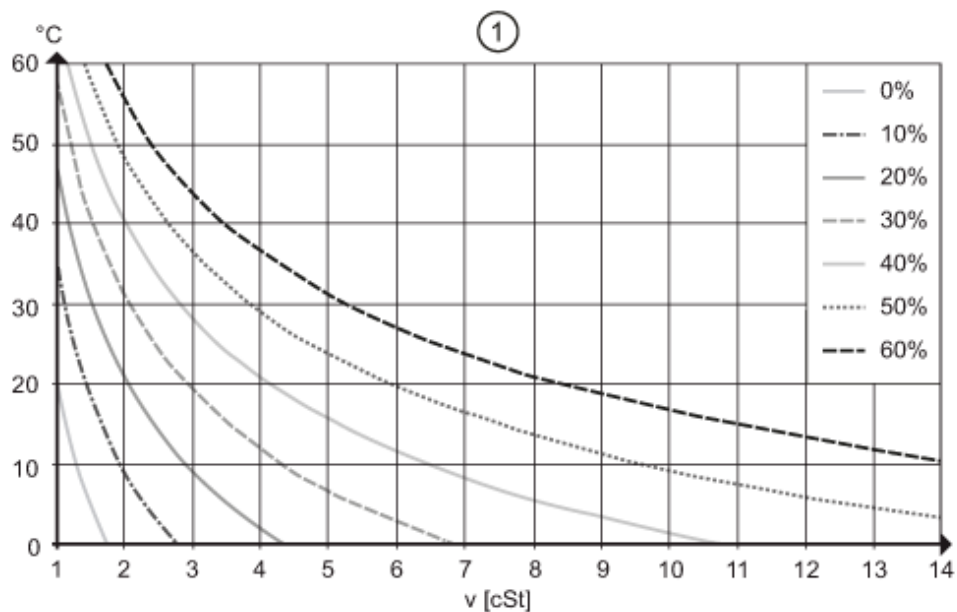

determination of the compensation value Q_0 for glycol-water mixtures

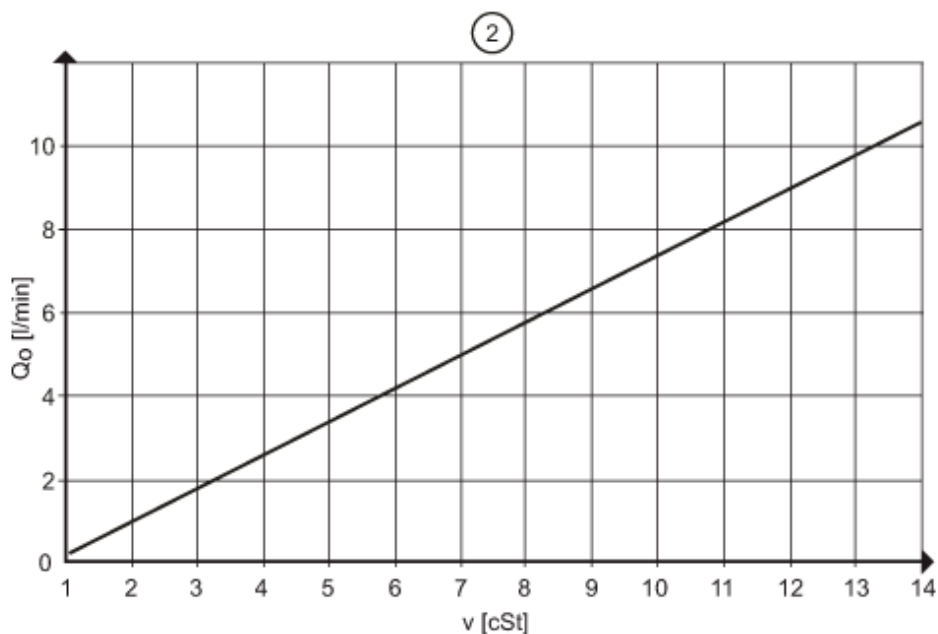

$\nu < 4$ cSt measuring accuracy 3% MEW

$4 < \nu < 14$ cSt measuring accuracy 4% MEW

SV8150



Vortex flow meter

SVM54XXXD0KG/US-100

response threshold Q_{\min}
depending on the kinematic viscosity

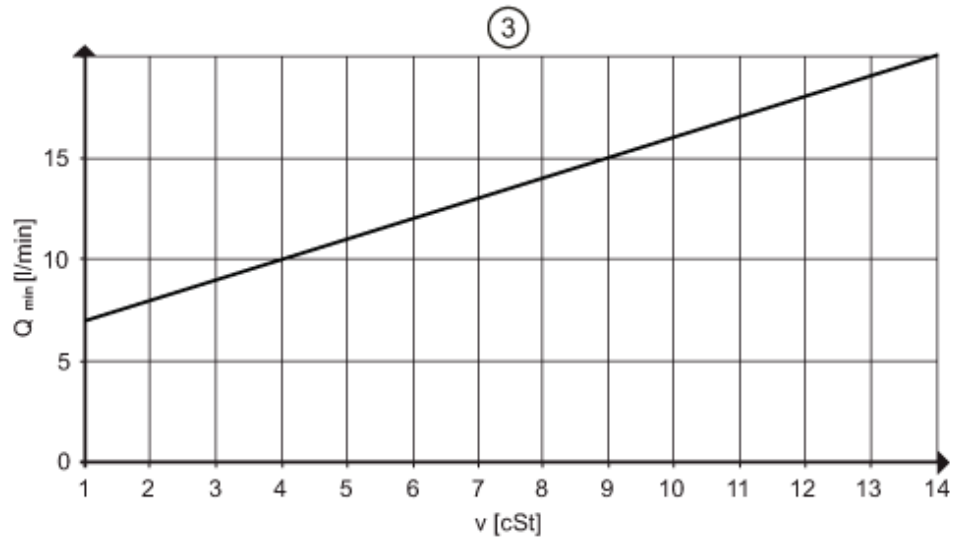

pressure rating (bar)

